

PART-I (SHORT QUESTIONS)

Q.2 Write short answers to any SIX (6) questions.

(i) Differentiate between spontaneous and non-spontaneous reactions.

Ans.	Spontaneous Reactions	Non-Spontaneous Reactions
	(1) "Spontaneous reactions are those which take place on their own without any external agent".	(1) "Non-spontaneous reactions are those which take place in the presence of an external agent."
	(2) They take place in an electrolytic cell.	(2) It takes place in a galvanic cell.
	(3) They are used to produce electricity.	(3) Electricity is used to drive these reactions.

(ii) Define oxidation in terms of addition/removal of oxygen/hydrogen. Give examples.

Oxidation

Oxidation can be defined in two ways:

Addition of Oxygen:

"A reaction in which oxygen combines with a substance (an element or a compound) is called an oxidation".

Examples:

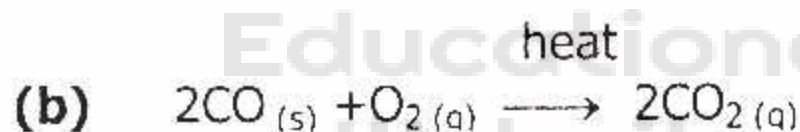
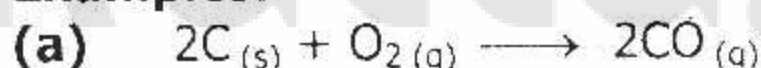

Removal of Hydrogen:

"A reaction in which hydrogen is removed from a compound is called an oxidation."

Examples:

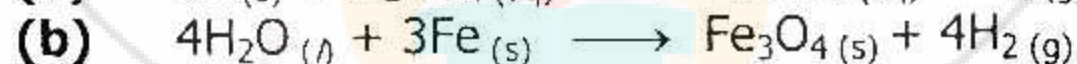
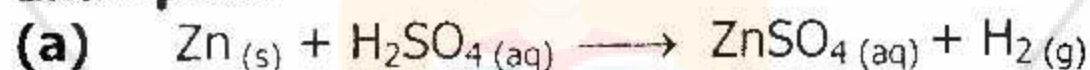

(iii) Define reduction in terms of addition/removal of oxygen/hydrogen. Give examples.

Ans. Reduction:

Reduction can be defined in two ways:

(1) Addition of Hydrogen:

"A reaction in which hydrogen combines with a substance (an element or a compound) is called a reduction".

Examples:

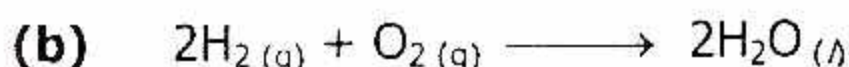
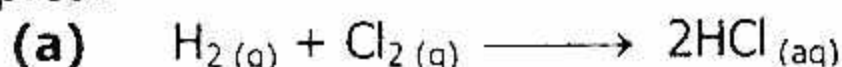

(2) Removal of Oxygen:

"A reaction in which oxygen is removed from a compound is called a reduction."

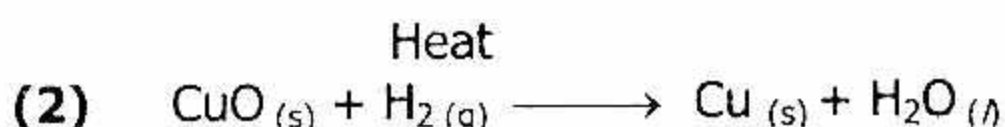
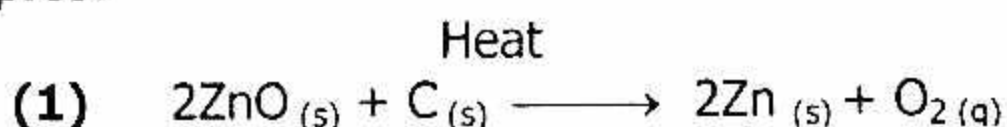
Examples:

(iv) **State oxidation in term of loss or gain of electrons. Give examples.**

Ans. **Oxidation:**

"Oxidation is loss of electrons by an atom or an ion."

Examples:

(1)

Oxidation

Removal of 2 Electrons

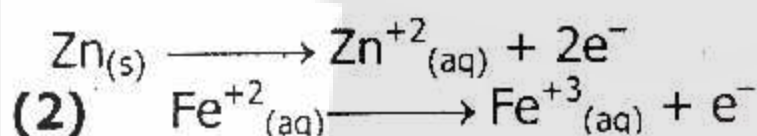
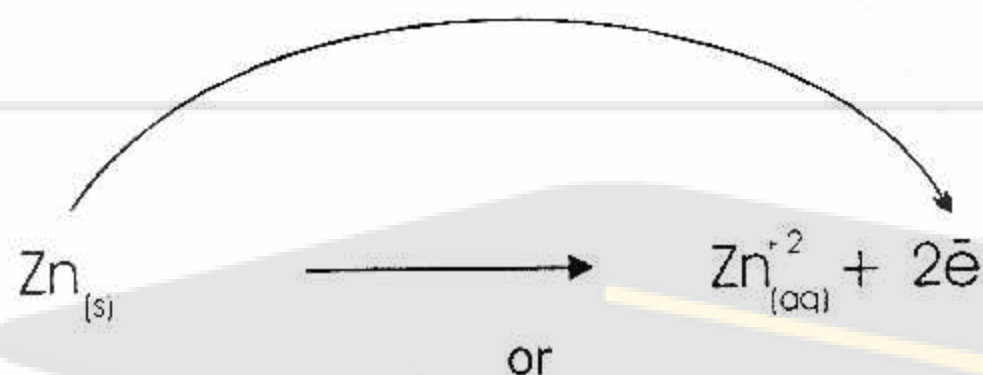

(v) **State reduction in term of loss or gain of electrons. Give examples.**

Ans. **Reduction:**

"Reduction is gain of electrons by an atom or an ion."

Examples:

(1)

Reduction

Gain of 2 Electrons

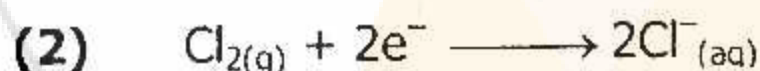
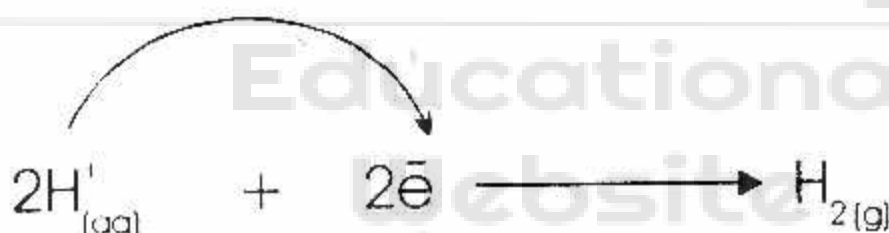

(vi) **Find oxidation number of nitrogen in HNO₃ when the oxidation numbers of H = +1 and O = -2.**

Solution:

We know that in a compound, the sum of all oxidation numbers is zero.

In case of HNO₃ it becomes:

$$[\text{O.N. of H}] + [\text{O.N. of N}] + 3[\text{O.N. of O}] = 0$$

Putting the values in above formula, we get

$$[+1] + [\text{O.N. of N}] + 3[-2] = 0$$

$$+1 + \text{O.N. of N} + [-6] = 0$$

$$\text{O.N. of Nitrogen} = 6 - 1$$

$$= +5$$

(vii) **Why the oxidation number of oxygen in OF₂ is +2?**

Ans.

In any substance the more electronegative atom has the negative oxidation number. The oxidation number of oxygen in its all compounds is -2. But the oxidation number of oxygen in OF₂ is +2. In OF₂ fluorine atom is more electronegative than oxygen atom. The electronegativity of F is 4.0 and that of O is 3.5. Oxygen is the positive part of the compound whereas F is the negative part of the compound. That is why in OF₂ the oxidation number of oxygen is +2. The O. No. of F is -1. Therefore, the O.N. of O is +2. It can be represented as following:

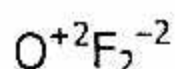

(viii) Write the reactions taking place at anode and cathode in Nelson's cell. Also write the overall reaction.

Ans. Reaction at Anode (Oxidation):

When electrolysis takes place, Cl^- ions are discharged at anode and Cl_2 gas rises into the dome at the top of the cell.

Equation:

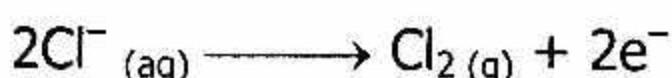

Reaction at Cathode (Reduction):

When electrolysis takes place, H^+ move towards cathode and are discharged there producing H_2 gas which escapes through the pipe.

Equation:

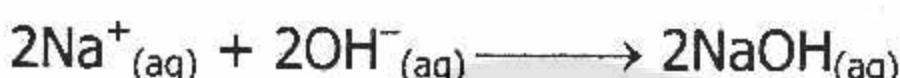

Overall Nelson's Cell Reaction:

Following overall cell reaction takes place in Nelson's cell during the electrolysis of brine.

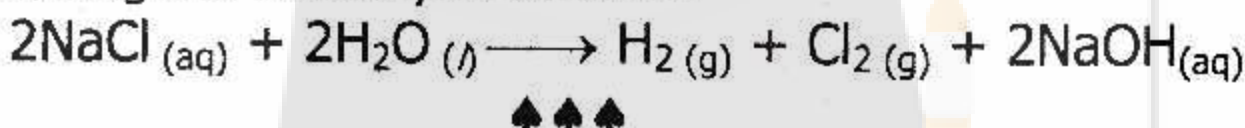

Q.4 Write short answers to any FIVE (5) questions.

(i) Define Corrosion. What is its chemical nature? Give examples.

Ans. Corrosion:

"Corrosion is slow and continuous eating away of a metal by the surrounding medium."

Chemical Nature of Corrosion:

Corrosion is chemically a redox chemical reaction (oxidation-reduction reaction) that takes place by the action of air and moisture with the metals.

Examples:

Rusting of iron and other metals are the most common examples of corrosion.

(ii) Explain the role of O_2 in rusting?

Ans. Role of O_2 in Rusting:

Oxygen plays an important role in the formation of rust. It is explained in the following steps:

(1) In the cathode region, the electrons released by iron reduce oxygen into water in the presence of H^+ ions.

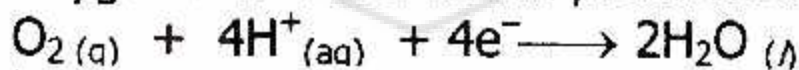

(2) The H^+ ions are provided by carbonic acid (H_2CO_3) formed when CO_2 from the air dissolves in water.

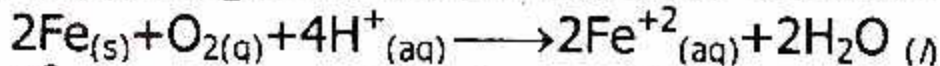

(3) The Fe^{2+} ions formed during rusting process spreads throughout the surrounding water and react with O_2 to form the salt $\text{Fe}_2\text{O}_3 \cdot n\text{H}_2\text{O}$ which is called rust.

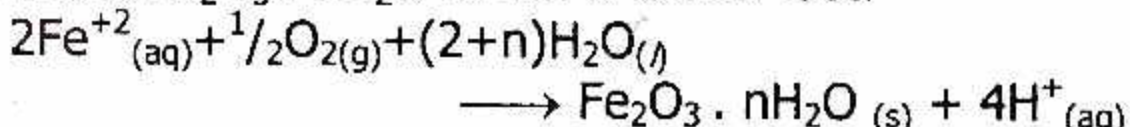

(iii) What is the difference between rusting and corrosion?

Ans.

(iv) What is meant by electroplating? What are its objectives?

Ans. Electroplating:

"Electroplating is depositing of one metal over the other by means of electrolyses."

Objectives of Electroplating: The objectives of electroplating are as under:

- (1) It is used to protect metals against corrosion.
 (2) It is used to improve the appearance of metals.
 (iv) **How electroplating of silver is carried out?**

Ans. Electroplating of Silver:

Principle:

"The electroplating of silver is carried out by establishing an electrolytic cell."

Method:

- (1) The pure piece of silver strip acts as anode that is dipped in silver nitrate solution.
 (2) The cathode is the metallic object to be coated such as silver spoon.
 (3) When the current is passed through the cell, the Ag^+ ions dissolve at the anode, and migrate towards the cathode where they discharge and deposit on the object e.g. spoon.

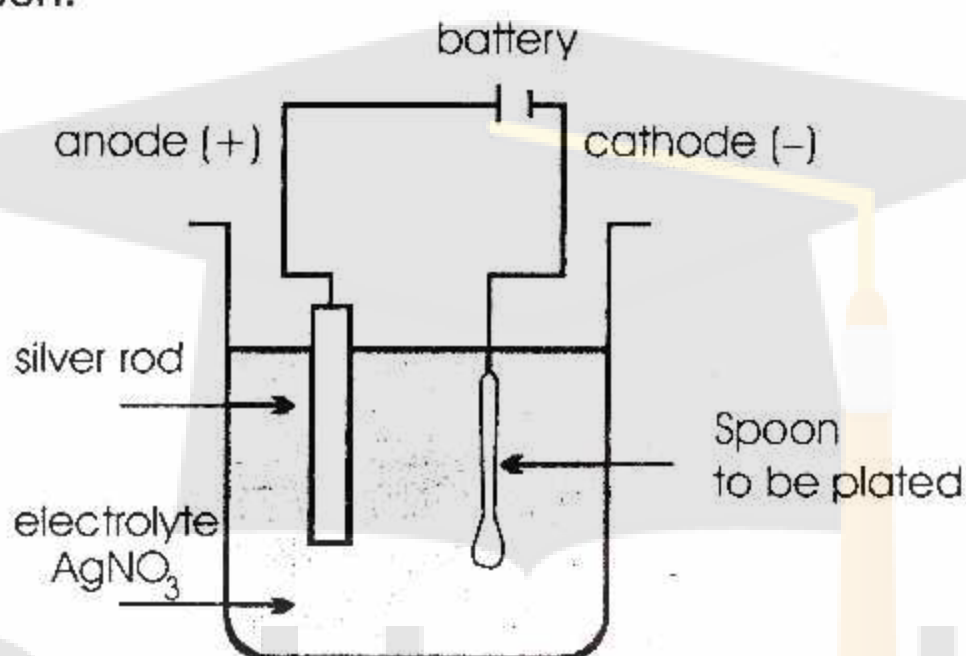

Fig.: Silver Electroplating of a Spoon

Chemical Reactions:

Following chemical reactions take place during the electroplating of silver.

At anode: $\text{Ag}_{(s)} \longrightarrow \text{Ag}^+_{(aq)} + e^-$

At cathode: $\text{Ag}^+_{(aq)} + e^- \longrightarrow \text{Ag}_{(s)}$

- (vi) **How electroplating of zinc is carried out?**

Ans. Electroplating of Zinc:

(1) The target metal is cleaned in alkaline detergent type solution, and it is treated with acid, in order to remove any rust or surface scales.

(2) Next, the zinc is deposited on the metal by immersing it in a chemical bath containing electrolyte zinc sulphate.

(3) A current is applied, which results in zinc being deposited on the target metal i.e. cathode.

- (vii) **Discuss, why galvanizing is considered better than that of tin plating?**

Ans. Advantaging of Galvanizing over Tin Coating:

The tin protects the iron only as long as its protective layer remains intact. Once it is broken and the iron is exposed to the air and water, a galvanic cell is established and iron rusts rapidly.

On the other hand, galvanizing protects the iron against corrosion even after the coating surface is broken.

That is why galvanizing is better than tin coating.

- (viii) **How electroplating of chromium is carried out?**

Ans. Procedure of Electroplating of Chromium

(1) The electroplating of chromium is carried out by establishing an electrolytic cell.

(2) The object to be electroplated acts as cathode while anode is made of antimonial-lead.